

Intel® NUC 11 Enthusiast Kit - NUC11PHKi7C

Intel® NUC 11 Enthusiast Mini PC - NUC11PHKi7CAA

User Guide

---

<January 2021>



You may not use or facilitate the use of this document in connection with any infringement or other legal analysis concerning Intel products described herein. You agree to grant Intel a non-exclusive, royalty-free license to any patent claim thereafter drafted which includes subject matter disclosed herein.

No license (express or implied, by estoppel or otherwise) to any intellectual property rights is granted by this document.

All information provided here is subject to change without notice. Contact your Intel representative to obtain the latest Intel product specifications and roadmaps.

The products described may contain design defects or errors known as errata which may cause the product to deviate from published specifications. Current characterized errata are available on request.

Copies of documents which have an order number and are referenced in this document may be obtained by calling 1-800-548-4725 or by visiting: <http://www.intel.com/design/literature.htm>.

Intel technologies' features and benefits depend on system configuration and may require enabled hardware, software or service activation. Performance varies depending on system configuration. No computer system can be absolutely secure.

Intel and the Intel logo are trademarks of Intel Corporation or its subsidiaries in the U.S. and/or other countries.

\*Other names and brands may be claimed as the property of others.

Copyright © 2021, Intel Corporation. All rights reserved.

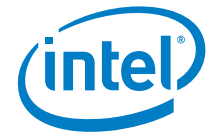

## Contents

---

<b>1.0</b>	<b>Introduction .....</b>	<b>5</b>
1.1	Before You Begin .....	5
1.2	Installation Precautions.....	6
1.3	Observe Safety and Regulatory Requirements.....	6
<b>2.0</b>	<b>Open the Chassis .....</b>	<b>7</b>
<b>3.0</b>	<b>System Memory .....</b>	<b>8</b>
<b>4.0</b>	<b>Change the M.2 SSD .....</b>	<b>11</b>
<b>5.0</b>	<b>Close the Chassis .....</b>	<b>13</b>
<b>6.0</b>	<b>Attaching and using the VESA Bracket (Optional).....</b>	<b>14</b>
<b>7.0</b>	<b>Connect Power .....</b>	<b>16</b>
<b>8.0</b>	<b>Install an Operating System .....</b>	<b>18</b>
<b>9.0</b>	<b>Install the Latest Device Drivers and Software.....</b>	<b>19</b>

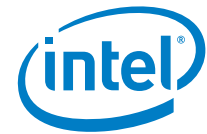

## ***Revision History***

---

<b>Date</b>	<b>Revision</b>	<b>Description</b>
<Jan 2021>	1.0	Initial release.

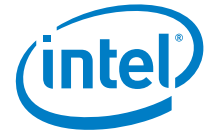

## 1.0 Introduction

---

This User Guide provides step-by-step installation instructions for these products:

- Intel® NUC 11 Enthusiast Kit - NUC11PHKi7C
- Intel® NUC 11 Enthusiast Mini PC - NUC11PHKi7CAA

### 1.1 Before You Begin



#### CAUTIONS

*The steps in this guide assume you're familiar with computer terminology and with the safety practices and regulatory compliance required for using and modifying computer equipment.*

*Disconnect the computer from its power source and from any network before performing any of the steps described in this guide.*

*Failure to disconnect power, telecommunications links, or networks before you open the computer or perform any procedures can result in personal injury or equipment damage. Some circuitry on the board can continue to operate even though the front panel power button is off.*

Follow these guidelines before you begin:

- Always follow the steps in each procedure in the correct order.
- Create a log to record information about your computer, such as model, serial numbers, installed options, and configuration information.
- Electrostatic discharge (ESD) can damage components. Perform the procedures described in this chapter only at an ESD workstation using an antistatic wrist strap and a conductive foam pad. If such a station isn't available, you can provide some ESD protection by wearing an antistatic wrist strap and attaching it to a metal part of the computer chassis.



## 1.2 Installation Precautions

When you install and test the Intel NUC, observe all warnings and cautions in the installation instructions.

To avoid injury, be careful of:

- Sharp pins on connectors
- Sharp pins on circuit boards
- Rough edges and sharp corners on the chassis
- Hot components (such as SSDs, processors, voltage regulators, and heat sinks)
- Damage to wires that could cause a short circuit

Observe all warnings and cautions that instruct you to refer computer servicing to qualified technical personnel.

## 1.3 Observe Safety and Regulatory Requirements

If you don't follow these instructions, you increase your safety risk and the possibility of noncompliance with regional laws and regulations.

## 2.0 *Open the Chassis*

---

1. Unscrew the 8 screws on the top side of the chassis (A) and lift the cover (B):

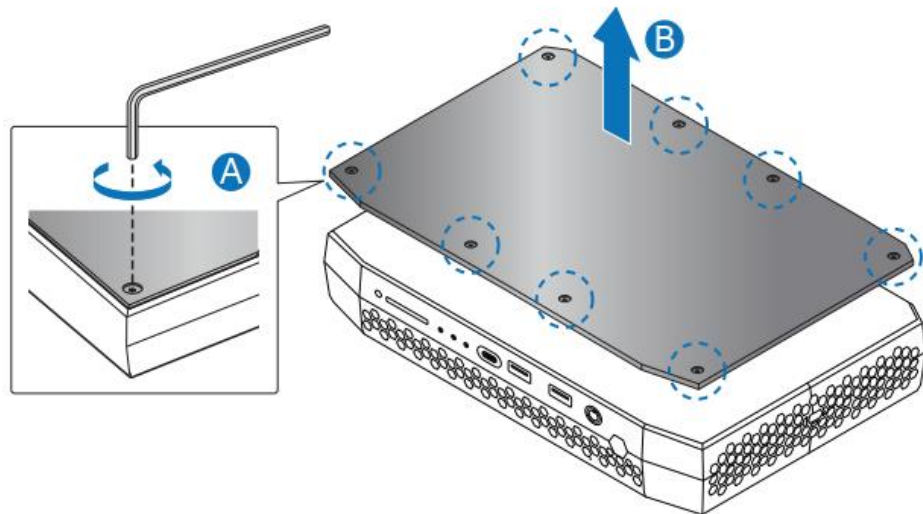

2. Unscrew the 5 screws on the metal plate (C) and lift it (D):

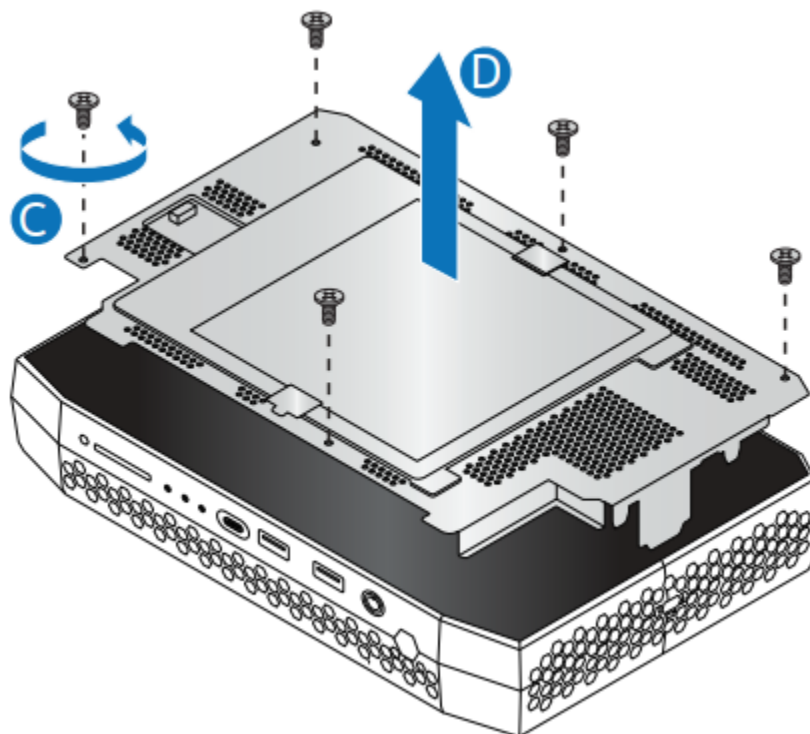



## 3.0 System Memory

---

Intel® NUC 11 Enthusiast Kit - NUC11PHKi7C and Intel® NUC 11 Enthusiast Mini PC - NUC11PHKi7CAA have two DDR4 SO-DIMM sockets. Be sure to select memory modules that meet these requirements:

- 1.2V low voltage memory
- 3200/2666MHz SO-DIMMs
- Max capacity - 64GB
- Non-ECC

Find compatible memory modules in the Intel Product Compatibility Tool

- [NUC11PHKi7C](#)
- [NUC11PHKi7CAA](#)

<b>NOTE</b>	If you plan to install only one memory module, install it in the upper memory socket.
-------------	---

### To install memory, follow these steps:

1. Observe the precautions in "Before You Begin" on page 5.
2. Turn off all peripheral devices connected to the computer. Turn off the computer and disconnect the power cord.
3. Remove the computer's top chassis cover and metal plate as described on page 7 (section 2.0)
4. Align the small space at the bottom edge of the memory module with the key in the socket.



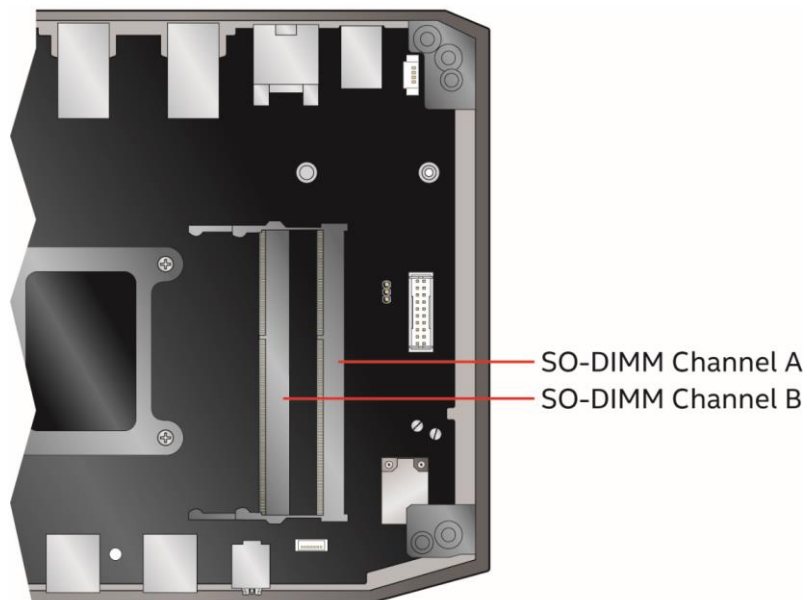
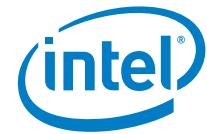

5. Insert the bottom edge of the module at a 45-degree angle into the socket (A).

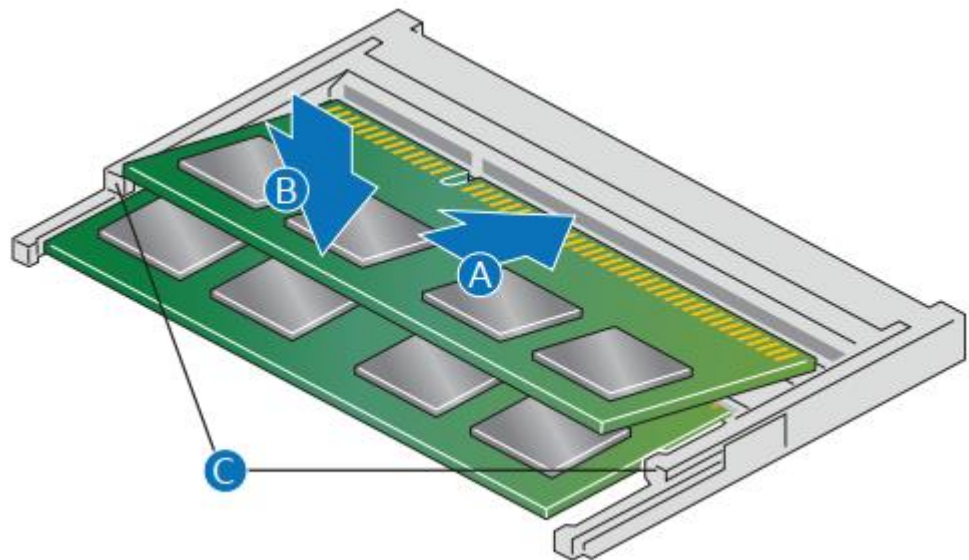

6. When the module is inserted, push down on the outer edge of module until the retaining clips snap into place (B). Make sure the clips are firmly in place (C).

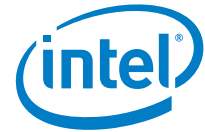

**To remove a SO-DIMM, follow these steps:**

1. Observe the precautions in "Before You Begin" on page 5.
2. Turn off all peripheral devices connected to the computer. Turn off the computer and disconnect the power cord.
3. Remove the computer's top chassis cover and metal plate.
4. Gently spread the retaining clips at each end of the memory socket, which causes the module to pop out of the socket (C).
5. Holding the module by the edges, lift it away from the socket, and store it in an anti-static package.
6. Reinstall and reconnect any parts you removed or disconnected to reach the memory sockets.
7. Replace the computer's cover and reconnect the power cord.

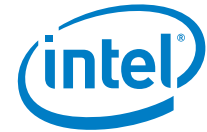

## 4.0 Change the M.2 SSD

Intel® NUC 11 Enthusiast Kit - NUC11PHKi7C and Intel® NUC 11 Enthusiast Mini PC - NUC11PHKi7CAA support dual 80 and single 110mm SSDs.

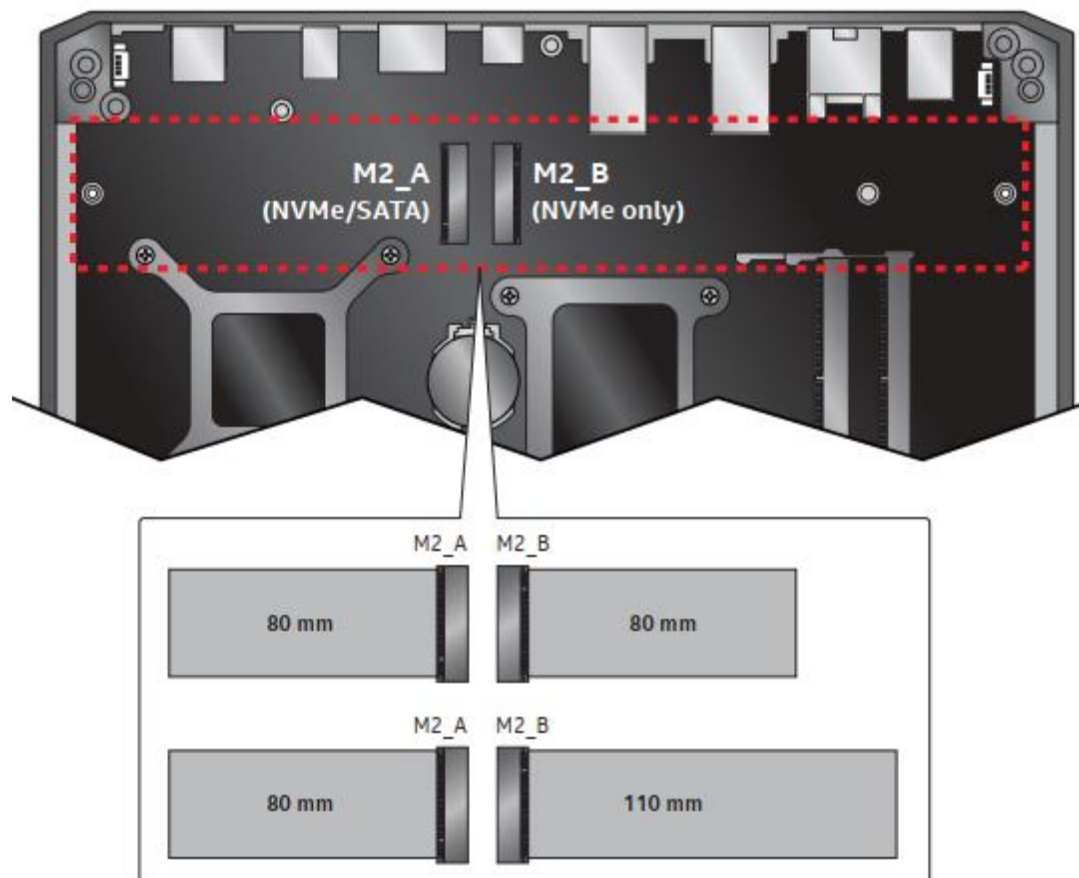

**There is pre-installed SSD available out of the box for the NUC11PHKi7CAA SKU:**

- Intel® Optane™ Memory H10 with Solid State Storage (512GB)

**Find compatible M.2 SSDs in the Intel Product Compatibility Tool:**

- [NUC11PHKi7C](#)
- [NUC11PHKi7CAA](#)

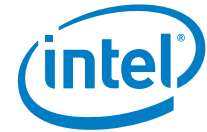

### To install a different M.2 SSD:

1. Remove the small silver screw from the 110mm or 80mm metal standoff on the board (A).
2. Remove the pre-installed SSD from the connector if there are any.
3. Make sure there is the metal standoff in the right position, depending on the length of the SSD you are going to install
4. Align the space at the bottom of the new M.2 SSD to the key on the connector (B).
5. Secure the card to the standoff with the small silver screw (C).

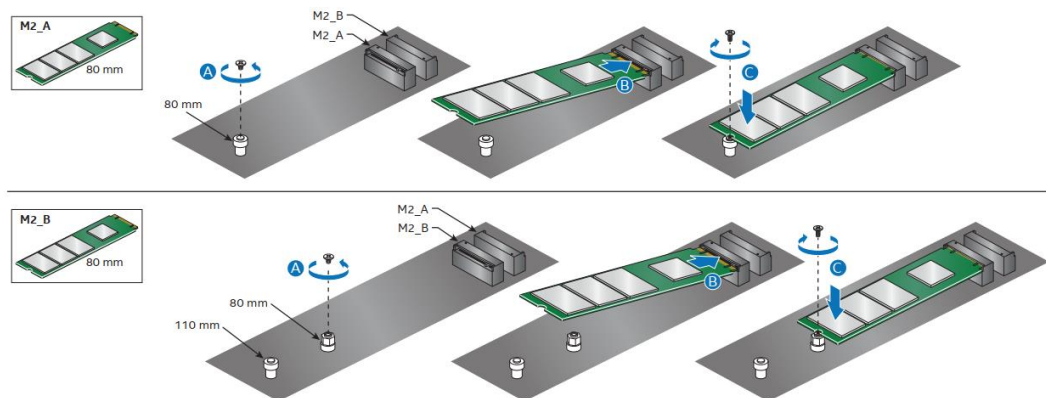

## 5.0 Close the Chassis

After all components have been installed, close the Intel NUC chassis. Intel recommends this be done by hand with a screwdriver to avoid over-tightening and possibly damaging the screws.

1. Place the top metal plate on the NUC chassis (A) and secure the screws with the screwdriver (B).

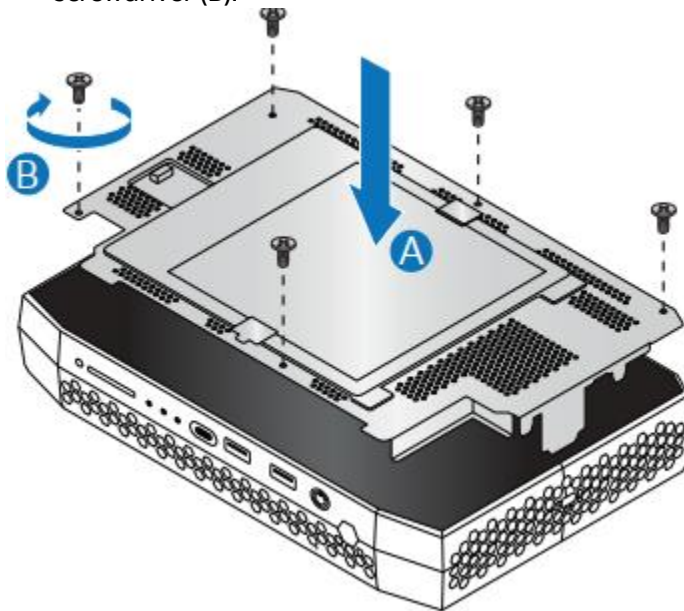

2. Place the top lid on top of the metal plate (C) and secure the screws with the screwdriver (D).

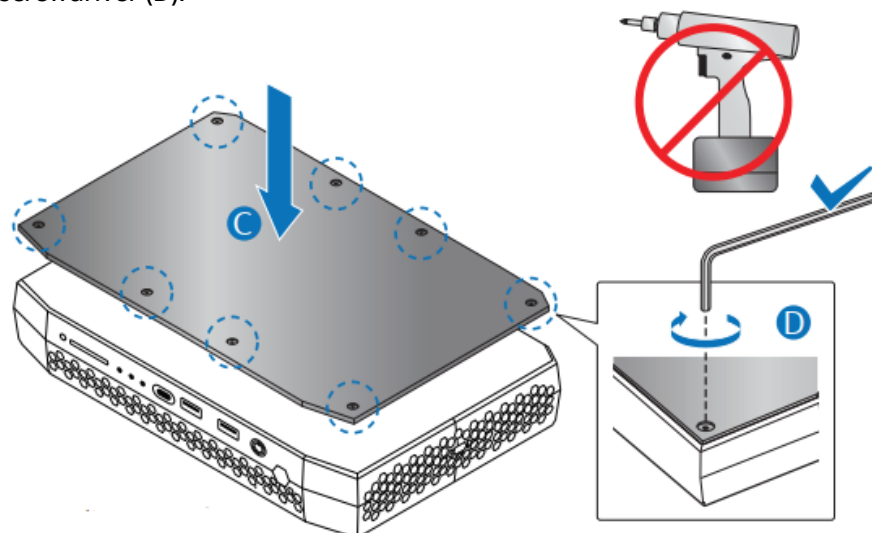

## 6.0 Attaching and using the VESA Bracket (Optional)

---

Follow the instructions to attach and use the VESA mount brackets:

1. Using the 4 small black screws that were included in the box, attach the VESA bracket to the back of the monitor or TV (A)

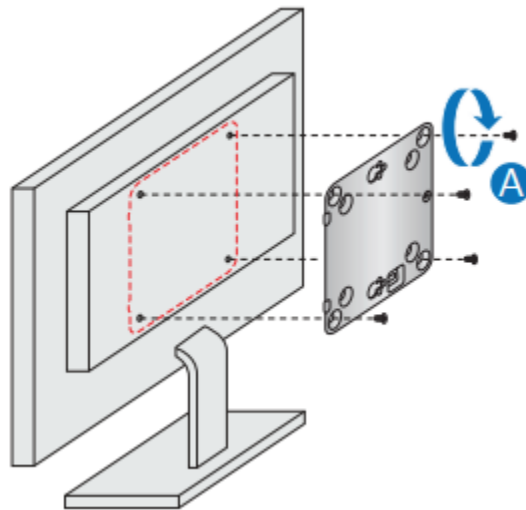

2. Attach two slightly larger black screws to the bottom chassis cover of the NUC (B)

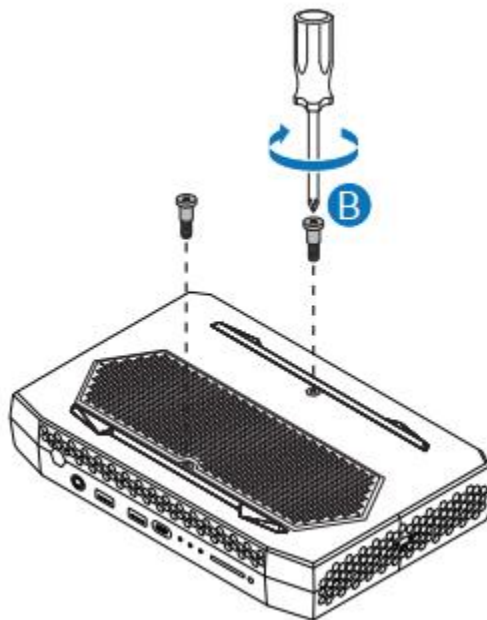

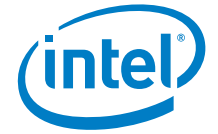



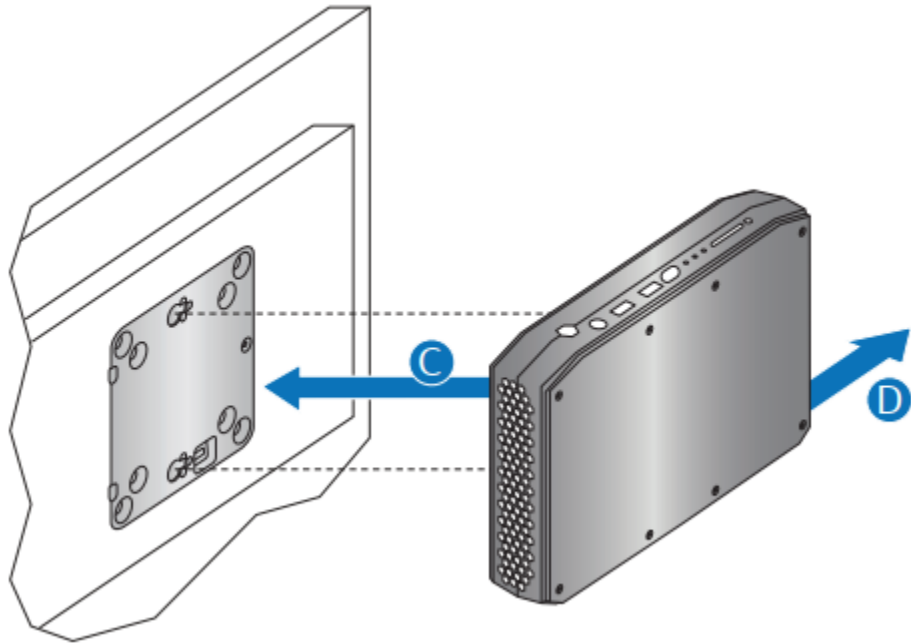

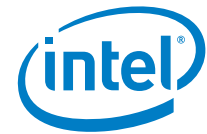

3. Place and slide the Intel NUC onto the VESA mount bracket (C and D)



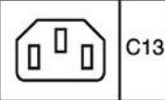

## 7.0 Connect Power

Each Intel NUC model includes either a region-specific AC power cord or no AC power cord.

Product codes	Power cord type
RNUC11PHKi7C000 RNUC11PHKi7CAA0	No power cord included. An AC power cord needs to be purchased separately. The connector on the power adapter is a C13 type connector. 
RNUC11PHKi7C001 RNUC11PHKi7CAA1	US power cord included. 
RNUC11PHKi7C002 RNUC11PHKi7CAA2	EU power cord included. 
RNUC11PHKi7C003	UK power cord included. 
RNUC11PHKi7C004	Australia/New Zealand power cord included. 
RNUC11PHKi7C005	India power cord included. 
RNUC11PHKi7C006 RNUC11PHKi7CAA6	China power cord included. 



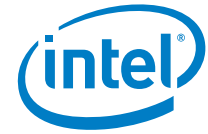

1. Connect the power cord to the adapter (A)
2. Plug the power cord into the wall (B)
3. Plug the power adapter into the NUC (C)

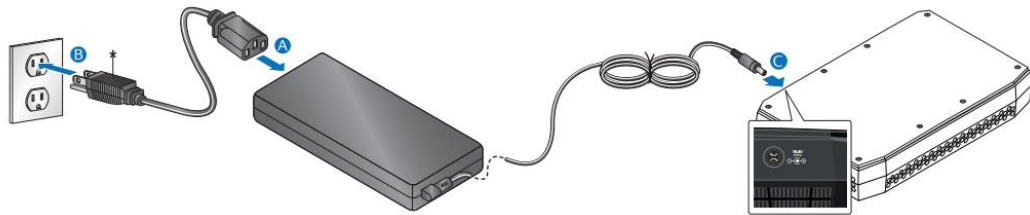



## **8.0** ***Install an Operating System***

---

See [Supported Operating Systems](#) for a list of Intel-validated Windows\* operating systems.

Refer to [Operating System Installation](#) for system requirements and installation steps.

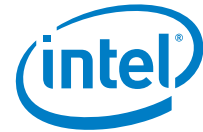

## 9.0 *Install the Latest Device Drivers and Software*

---

Here are the options for keeping device drivers current:

- Allow the [Intel® Driver & Support Assistant \(Intel® DSA\)](#) to detect out-of-date drivers
- Manually download drivers, BIOS, and software from Download Center:
  - [NUC11PHKi7C](#)
  - [NUC11PHKi7CAA](#)

The following device drivers and software are available.

- Intel® Chipset Device Software
- Intel® Graphics
- nVidia® Discrete Graphics
- Intel® Management Engine
- Intel® Gigabit Ethernet
- Intel® Wireless
- Intel® Bluetooth
- Realtek\* High Definition Audio
- Intel® Rapid Storage Technology
- Thunderbolt® Networking Driver
- USB Type C Power Delivery
- GNA Scoring Accelerator
- ITECIR Infrared Receiver (EC)
- Realtek PCIE Card Reader
- Intel® Serial IO